

Search

Alerts

Lists

My Scopus

1 of 1

[Export](#) | [Download](#) | [Add to List](#) | [More...](#)

Maejo International Journal of Science and Technology

Volume 9, Issue 3, 23 December 2015, Pages 403-412

[Open Access](#)

## Automated three-wheel rice seeding robot operating in dry paddy fields (Article)

 Ruangurai, P.<sup>a</sup>, Ekpanyapong, M.<sup>b</sup>, Pruetong, C.<sup>b</sup>, Watwai, T.<sup>c</sup>
<sup>a</sup> Rajamangala University of Technology Phra Nakhon, No.399, Samsen Road, Dusit Sub-area, Dusit Area, Bangkok province, Thailand

<sup>b</sup> Microelectronics and Embedded Systems, Asian Institute of Technology, Km. 42 Klong Luaong, Pathumthani, Thailand

<sup>c</sup> Department of Banking and Finance, Chulalongkorn University, Phayathai Road, Patumwan, Bangkok, Thailand

[View additional affiliations](#)
[View references \(11\)](#)

### Abstract

Automated farming robots can help address the labour shortage issue in the agricultural sector. In this paper, a automated direct rice seeding robot is introduced. The machine is capable of controlling the number of rice seeds per dropping point as well as the distance between the dropping points, as well as navigating automatically in the paddy field. In a field test an accuracy of 92% for the number of seeds dropped and only an error of about 5 centimetres in the dropping location were achieved. © 2015 by Maejo University, San Sai, Chiang Mai, 50290 Thailand.

### Author keywords

Agricultural machinery; Direct rice seeding; Embedded systems; Rice seeding robot; Robotics

ISSN: 19057873 Source Type: Journal Original language: English

Document Type: Article

Publisher: Maejo University

### References (11)

[View in search results format](#)
 All [Export](#) | [Print](#) | [E-mail](#) | [Create bibliography](#)

- Nishimura, Y., Hayashi, K., Goto, T., Horio, M.  
 1 Precision-drilling methods for the direct sowing of rice in flooded paddy fields (2005) *Proceedings of World Rice Research Conference*, pp. 238-240. Tsukuba, Japan
- Nagasaka, Y., Taniwaki, K., Otani, R., Shigeta, K.  
 2 "An automated rice transplanter with RTKGPS and FOG" (2002) *Agric. Eng. Int. CIGR J. Sci. Res. Devel*, 4, pp. 41-46.
- Nagasaka, Y., Kanetani, Y., Umeda, N., Kokuryu, T.  
 3 High-precision autonomous operation using an unmanned rice transplanter (2005) *Proceedings of World Rice Research Conference*, pp. 235-238. Tsukuba, Japan
- Yoshinaga, S.  
 4 **Improved lodging resistance in rice (*Oryza sativa* L.) cultivated by submerged direct seeding using a newly developed hill seeder** (2005) *Japan Agricultural Research Quarterly*, 39 (3), pp. 147-152. [Cited 5 times](#).  
[View at Publisher](#)

Cited by 1 document

#### Agricultural robots for field operations: Concepts and components

 Bechar, A., Vigneault, C.  
 (2016) *Biosystems Engineering*
[View details of this citation](#)

Inform me when this document is cited in Scopus:

[Set citation alert](#) | [Set citation feed](#)

Related documents

#### Development of a Low-cost IMU by using sensor fusion for attitude angle estimation

 Liu, Y., Noguchi, N., Ishii, K.  
 (2014) *IFAC Proceedings Volumes (IFAC-PapersOnline)*

#### Measurement of automotive catalyst washcoat loading parameters by microscopy techniques

 Plummer Jr., H.K., Baird, R.J., Hammerle, R.H.  
 (1999) *Microscopy and Microanalysis*

#### Nanogram scale determination of the volume change of solidification of an indium-rich alloy by AFM

 Yuan, W.L., Liu, W.K., O'Rear, E.A.  
 (1998) *Journal of Materials Science Letters*
[View all related documents based on references](#)

Find more related documents in Scopus based on:

[Authors](#) | [Keywords](#)

- Chaorakam, I., Koike, M., Takigawa, T., Yoda, A., Hasegawa, H., Bahalayodhin, B.  
5 Field evaluation of slot openers for minimum tillage (part 3)-dried soil cover on the slot  
(2009) *Maejo Int. J. Sci. Technol.*, 1, pp. 95-105. [Cited 2 times.](#)  
(Sp. Iss.)
- Noguchi, N., Barawid Jr., O.C.  
6 **Robot farming system using multiple robot tractors in Japan agriculture**  
(2011) *IFAC Proceedings Volumes (IFAC-PapersOnline)*, 18 (PART 1), pp. 633-637. [Cited 4 times.](#)  
ISBN: 978-390266193-7  
doi: 10.3182/20110828-6-IT-1002.03838  
[View at Publisher](#)
- Watwai, T., Pruetong, C., Ekpanyapong, M.  
7 A tray-based direct rice seeding machine  
(2014) *DIP Thailand 1301007037*
- Weinstein, A.J., Moore, K.L.  
8 **Pose estimation of Ackerman steering vehicles for outdoors autonomous navigation**  
(2010) *Proceedings of the IEEE International Conference on Industrial Technology*, art. no. 5472738, pp. 579-584. [Cited 9 times.](#)  
ISBN: 978-142445697-0  
doi: 10.1109/ICIT.2010.5472738  
[View at Publisher](#)
- Aranda, J., Diaz, J.M., Canto, S.D., Munoz, R., Cuesta, C.H.  
9 An overview about dynamic positioning of ships  
(2005) *Automation for the Maritime Industries*  
(Ed. J. Aranda, M. A. Armada and J. M. De la Cruz), 1st Edn., Produccion Grafica Multimedia, Madrid, Ch.4
- Dorf, R.C.  
10 (2004) *The Engineering Handbook*, pp. 105-9-105-10. [Cited 70 times.](#)  
2nd Edn., CRC Press, Boca Raton
- Nakwattanukul, S., Mongkoltanatas, J., Sarathunphithak, D., Chaisattapagon, C.  
11 (2007) *Testing and development of rice planters attached to farm tractor*  
Final Research Report, Department of Agricultural, Thailand

---

 Ekpanyapong, M.; Microelectronics and Embedded Systems, Asian Institute of Technology, Km. 42  
Klong Luaong, Thailand; email:[mongkol@ait.ac.th](mailto:mongkol@ait.ac.th)  
© Copyright 2016 Elsevier B.V., All rights reserved.

---

*Technical Note*

## **Automated three-wheel rice seeding robot operating in dry paddy fields**

Piyanun Ruangurai<sup>1</sup>, Mongkol Ekpanyapong<sup>2,\*</sup>, Chatchai Pruetong<sup>2</sup> and Thaisiri Watwai<sup>3</sup>

<sup>1</sup> Faculty of Industrial Education, Rajamangala University of Technology Phra Nakhon, No. 399, Samsen Road, Dusit Sub-area, Dusit Area, Bangkok province 10300, Thailand

<sup>2</sup> Microelectronics and Embedded Systems, Asian Institute of Technology, Km. 42 Klong Luaong, Pathumthani 12120, Thailand

<sup>3</sup> Department of Banking and Finance, Faculty of Commerce and Accountancy, Chulalongkorn University, Phayathai Road, Patumwan, Bangkok 10330, Thailand

\* Corresponding author, e-mail: [mongkol@ait.ac.th](mailto:mongkol@ait.ac.th)

*Received: 22 January 2014 / Accepted: 4 December 2015 / Published: 23 December 2015*

---

**Abstract:** Automated farming robots can help address the labour shortage issue in the agricultural sector. In this paper, a automated direct rice seeding robot is introduced. The machine is capable of controlling the number of rice seeds per dropping point as well as the distance between the dropping points, as well as navigating automatically in the paddy field. In a field test an accuracy of 92% for the number of seeds dropped and only an error of about 5 centimetres in the dropping location were achieved.

**Keywords:** direct rice seeding, agricultural machinery, robotics, rice seeding robot, embedded systems

---

### **INTRODUCTION**

Rice is one of the most important economic crops in Asia. In the past rice farming required intensive human labour. However, workers throughout the region have been moving to work for higher-paying industrial jobs, leading to labour shortages in the agricultural sector. With the technology advancement, more tools have been introduced to the farmers. These tools can help address this labour-shortage problem and at the same time improve farming efficiency. Nishimura et al. [1] introduced a precision-drill seeder for the direct sowing of rice in flooded paddy fields. They used an 8-row seeder mounted on a vehicle. Their machine had two parts: the first part was the seeding part and the second part was the fertilising part. The system was operated manually. Nagasaka et al. [2] proposed an automated rice transplanter with a real-time kinematic global positioning system (RTKGPS) and a fibre optic gyro. Their objective was to develop an automated system for a precise operation on paddy fields. They used the RTKGPS to locate the position and

the fibre optic gyro sensor to measure the direction and inclination of the robot. The vehicle could move in a straight line automatically and the deviation from the desired straight path was less than 10 cm. Nagasaka et al. [3] introduced a high-precision automated, unmanned rice transplanter. The system was operated using a RTKGPS with 2-cm precision at 10Hz. They used a simple proportional controller for steering control. The transplanter was guided by a global positioning system (GPS) with a maximum deviation of 12 cm from the desired straight path and a root mean square (RMS) deviation of 5.5 cm. However, the drawback of the RTKGPS is that it requires the setting up of a base station prior to operating the system. Hence it is not practical for actual farming. Yoshinaga [4] developed a hill seeder and improved the lodging resistance of hill-seeded rice in Japan. He developed the seeder that effectively drives seeds intermittently into the puddled soil and enabled the establishment of several kinds of plants on a hill.

Apart from rice farming, there are other kinds of crop farming that have incorporated the technology for efficiency improvement. Chaorakam et al. [5] performed a field evaluation of slot openers for minimum tillage, which may help retain soil moisture, reduce time requirement and save fuel consumption for soil preparation. Noguchi and Barawid [6] introduced a farming robot which uses low-cost navigation and a real-time monitoring system. The navigation system uses a Hemisphere GPS, which is an inexpensive sensor in place of the inertial measurement unit (IMU). It provides minimum errors both in lateral and heading deviations. They also used an inexpensive GPS sensor instead of the RTKGPS and IMU sensors. With those inexpensive sensors, the robot could follow the navigation map with good accuracy, although it was less accurate than the robot with more expensive systems (RTKGPS and IMU). They used a laser scanning system to detect objects in the farm but this sensor is expensive. They also introduced a real time monitoring system to observe the status of each robot.

As a larger proportion of the labour force is moving to higher-paying jobs in manufacturing industries in the cities or suburban areas, a labour shortage in the agricultural sector in most developing countries becomes more severe and the introduction of agricultural machinery becomes increasingly important. Examples of rice farming machinery include rice harvesters and rice transplanters. However, labour is still needed for most part of rice farming even with rice transplanters. Here we introduce an automated direct rice seeding robot which is capable of controlling the number of rice seeds per dropping point as well as the distance between the dropping points, and navigates automatically in the paddy field. We propose a novel mechanic design and a mathematical model for the dynamic control of a three-wheel robot in the paddy field. Most existing agricultural machines are based on a four-wheel system. The advantage of a three-wheel robot over a four-wheel one is the ease of steering control for making turns. We apply the extended Kalman filter (EKF) algorithm for sensor fusion to an accurate tracking of our robot system and provide proportional-integral-derivative (PID)-based and proportional-derivative (PD)-based control systems for driving control and steering control respectively.

## **MATERIALS AND METHODS**

### **Rice Seeding System**

The rice seeding system [7] used in this study consists of two subsystems: the rice seed container as shown in Figure 1 and the ground vehicle as shown in Figure 2. The top of the rice seed container is a tray partitioned by flat aluminum bars into 50 x 49 cells (50 rows x 49 columns), each of size 1 x 1 cm<sup>2</sup>, for containing seeds before planting. A plastic plate is placed under the

aluminum bars for keeping the seeds in the tray. A stepper motor is used to drive a ball screw which pulls the plastic plate. Each time the plate is pulled, it opens one row (49 cells) of the tray to drop 49 seeds (if one cell contains one seed) to the slot box. The seeds then fall to the ground through 49 small PVC pipes arranged in a 7 x 7 grid as shown in Figure 2(c). The seeding system is designed so that more trays can be added on the top to carry more rice seeds. The ground vehicle carries the rice seed container on the top and drops the seeds when it reaches the seed dropping location. The vehicle has three wheels: two rear wheels for driving the robot and one front wheel for controlling the direction. The front wheel is a standard bicycle wheel and the rear wheels are cartwheels. The advantage of a three-wheel robot over one with four wheels is the ease of steering control. To ensure that the vehicle is strong enough for a rough terrain, the main structure is made from steel bars. The rice seeding system is attached to the support frame which is made from aluminum to minimise the total weight. For each driven wheel, a 500W DC motor is used for robot mobilisation. An incremental encoder (wheel encoder) is attached at the end of each motor to measure the velocity of each wheel. A 36W DC motor is used to drive the front wheel for steering control. An encoder (heading encoder) is also attached to its shaft for measuring the steering angle. Table 1 provides the detailed information of the robot.

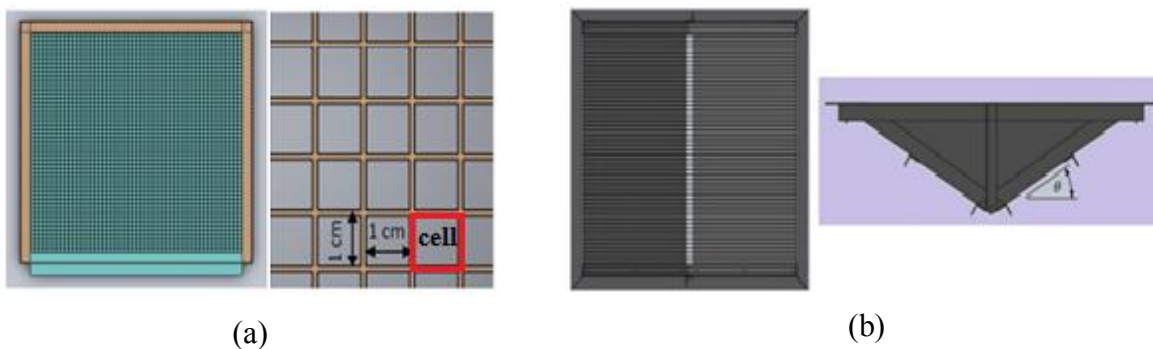

**Figure 1.** Rice seed container: (a) tray for containing rice seeds; (b) slot box

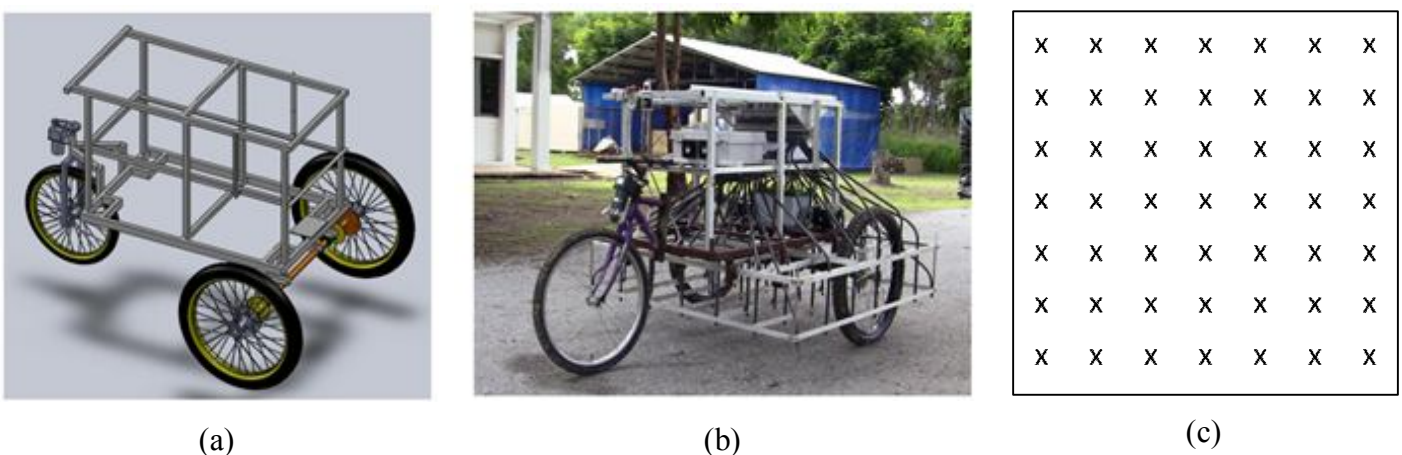
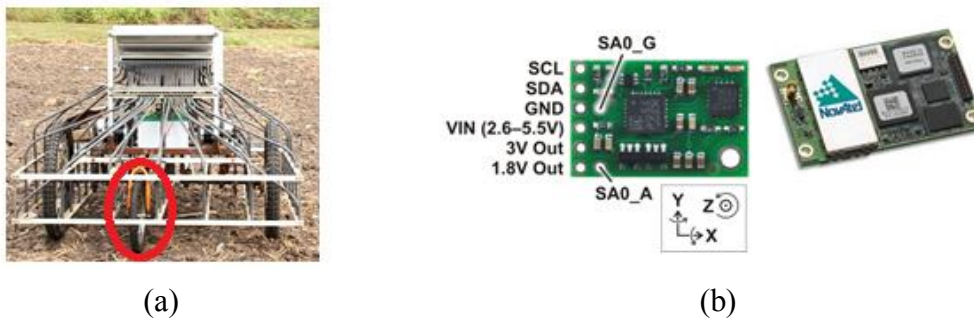

**Figure 2.** Ground vehicle: (a) frame in solid work; (b) real robot; (c) PVC pipe end arrangement

**Table 1.** Three-wheel robot information

Item	Detail
Width x length x height	1.4 x 2.25 x 1.2 m
Rear-wheel diameter	66 cm
Front-wheel diameter	58 cm
Motor	500W DC
Weight	90 kg
Power source	battery

Since it is possible that on a rough surface in the field a slip may occur at a rear wheel and cause a measurement error, a small additional wheel with an encoder is added to the vehicle as shown in Figure 3(a) to measure the robot's travel distance instead of solely relying on the information from the two rear wheels. A compass and a GPS as shown in Figure 3(b) are also used in this robot for localising and path tracking purposes.

**Figure 3.** Motion control devices: (a) additional wheel with encoder; (b) IMU and GPS

### Automated Control System

The EKF algorithm is adopted to estimate the current position and predict the next position of the robot. The steering control of the front wheel motor is used to track the robot angle along the desired path. The system has three types of sensor: GPS, compass and wheel encoder. The sensor fusion is used for high-accuracy location estimation with respect to the orientation to true north and travel distance of the robot. We did not use a differential GPS such as RTKGPS because it requires setting up a base station which is not practical for Thai farming. The coordinate system of the rice planting robot is shown in Figure 4. A negative value of  $\delta$  means the front wheel is turned towards the left side of the steered wheel axle and a positive  $\delta$ , the right side. The system state consists of the robot's position in the X-axis and Y-axis ( $x, y$ ) and the orientation ( $\theta$ ) of the robot with respect to the X-axis;  $\theta = 0$  represents the inclination along the north direction. At system time, the system state is denoted by

$$X_t = [x_t \ y_t \ \theta_t]^T,$$

where  $A^T$  is the transpose of matrix  $A$ .

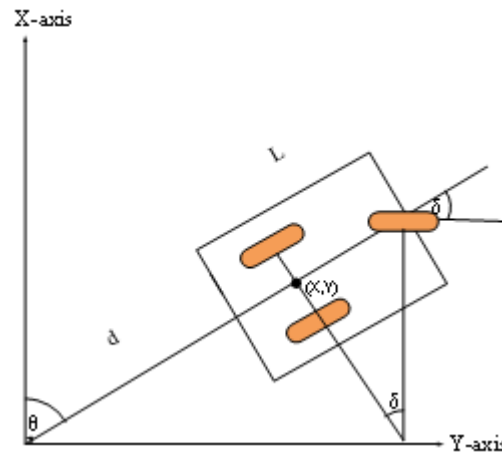

**Figure 4.** Robot model ( $x, y$  = robot position,  $d$  = travel distance,  $L$  = vehicle length,  $\delta$  = steering angle,  $\theta$  = robot orientation)

The motion model in this invention is based on odometry. The input of the motion model at system time  $t$ ,  $U_t$ , is given by

$$U_t = [d_t \quad d_t \tan(\delta_t)]^T$$

where the travel distance of the robot,  $d_t$ , is collected from the wheel encoders, and the steering angle  $\delta_t$  comes from the heading encoder. We use the Ackerman model [8] in discrete time for our motion model. The equation for the model is

$$X_{t+1} = X_t + \begin{bmatrix} \cos(\theta_t) & 0 \\ \sin(\theta_t) & 0 \\ 0 & \frac{1}{L} \end{bmatrix} U_t + V_t$$

where the process noise  $V_t$  is a zero-mean white Gaussian noise. In general, the process noise covariance is difficult to estimate because we do not directly observe the process noise. However, it can be obtained by tuning [9]. The measurement output  $Y_t$  is the position on the X-axis and Y-axis obtained from the GPS sensor and it is assumed [10] that

$$Y_t = X_t + W_t$$

where the measurement noise  $W_t$  is assumed to be a Gaussian noise with zero mean.

There are two subsystems for path tracking in our rice planting robot. The first is the heading control system for controlling the heading of the robot towards the waypoint, and the second is the velocity control system for stopping or moving the robot at a constant speed. The block diagram of the heading control system (Figure 5) is a multi-loop system in which the outer loop is for adjusting the vehicle's direction and the inner loop, the front wheel. For the outer loop, the system obtains the current position  $(X_c, Y_c)$  from the localisation method. The input of this system is the desired yaw angle,  $\theta_{desired}$ , which is obtained from the trigonometric function. The system obtains the current yaw angle,  $\theta_{local}$ , from the localisation method and calculates the error between the desired and the current yaw angles or  $e_1(t)$ . The desired steering angle is proportional to  $e_1(t)$ , with proportional gain  $K_{p1}$ . The feed forward gain of the heading control loop for the curve line is  $K_{p2}$ , whereas it is zero for straight line. The vehicle speed control diagram is shown in Figure



6. The pulse width modulation (PWM) is used for controlling the speed of the motor of the rear wheels. The PID controller is used for this system and its equation is:

$$PWM = K_p e(t) + K_i \int_0^t e(s) ds + K_d \frac{de(t)}{dt}$$

where  $K_p$ ,  $K_i$  and  $K_d$  are gains.

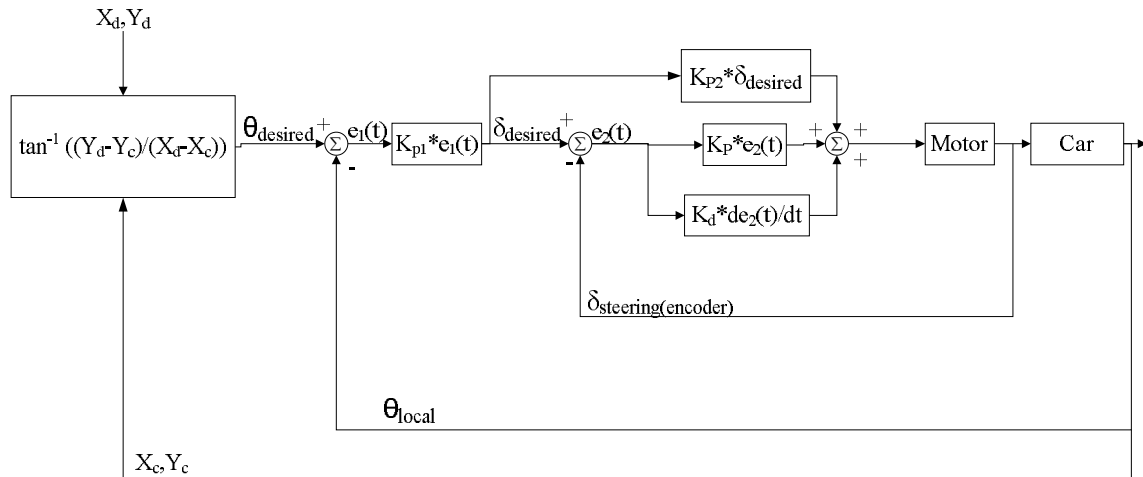

Figure 5. Heading control loop

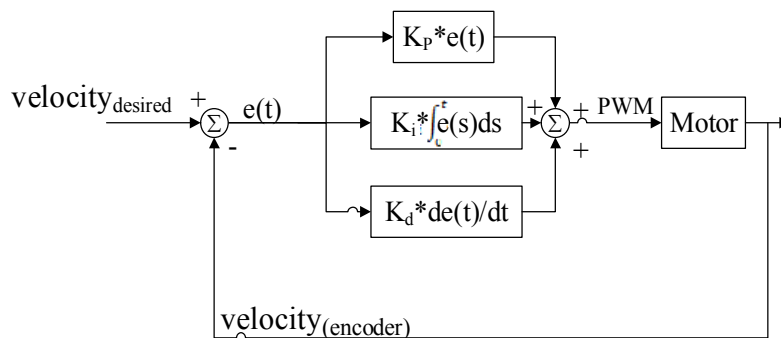

Figure 6. Velocity control system

**RESULTS AND DISCUSSION**

**Simulation Results on Localisation Based on EKF**

We tested the performance of the EKF-based localisation using simulation in Matlab. In the simulation we set the length of the vehicle  $L$  to 1.4 m., the travel distance  $d$  to 2 m and the steering angle  $\delta$  to 0.07 rad. The covariance matrices of the process noise  $V_t$  and measurement noise  $W_t$  were assumed to be diagonal. The diagonal entries of  $V_t$  were  $0.12^2$ ,  $0.14^2$  and  $0.01^2$ , and those of  $W_t$  were  $1.2^2$ ,  $1.4^2$  and  $0.037^2$ . The position of the vehicle was simulated based on the process equation. The position was updated and plotted as the true path every 0.1 second, which was a circular path. The measured path was obtained from the true path plus the measurement noise  $W_t$ . The model path was calculated from the dynamics of the robot assuming the process noise  $V_t$  was



zero, and the EKF path was calculated using the EKF algorithm. The results are shown in Figure 7, where the positions of the EKF path are closer to the true path than are those of the measured and model paths. A comparison between the measured, EKF and model path errors in the X-axis and Y-axis shows that the EKF path error is the smallest.

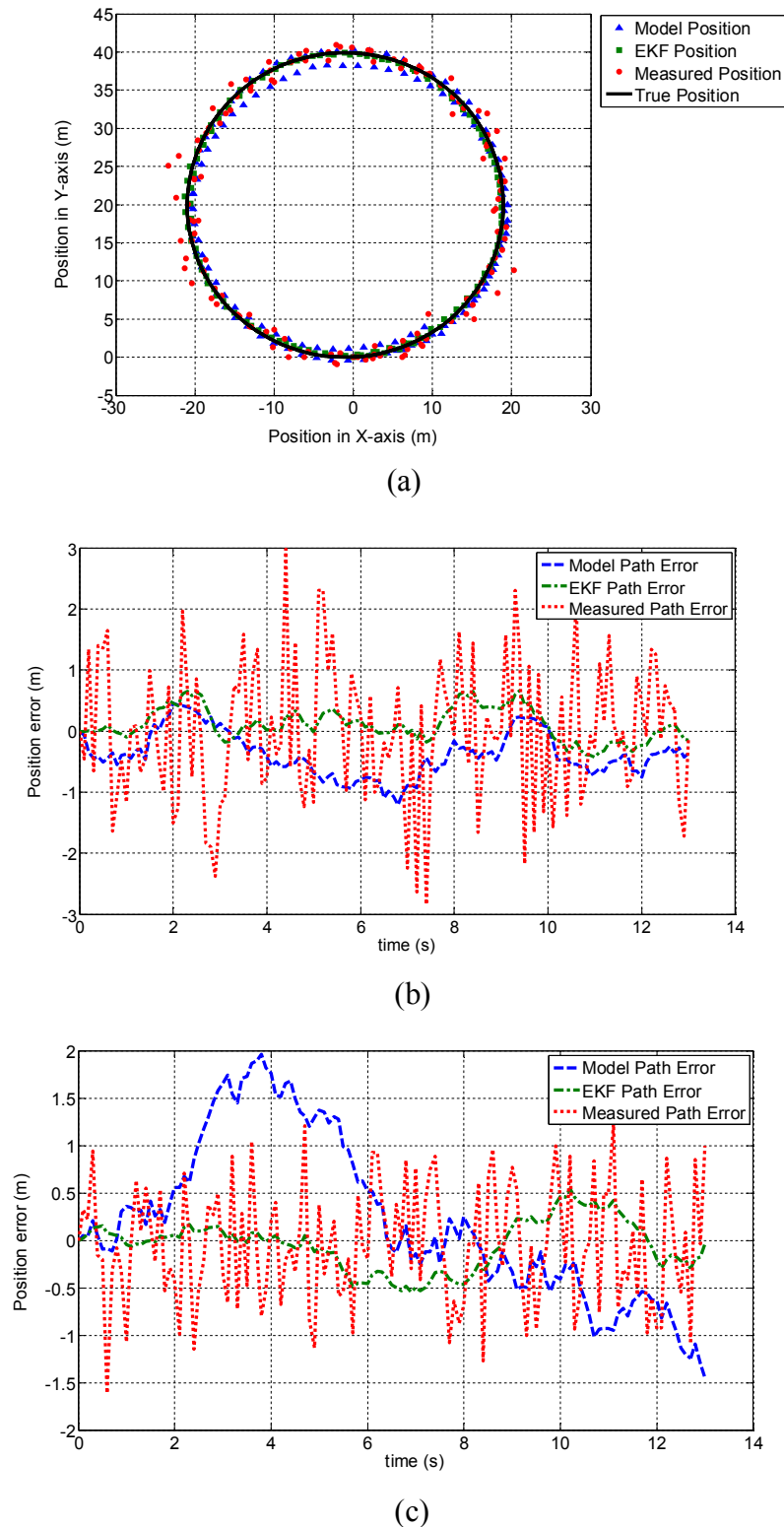
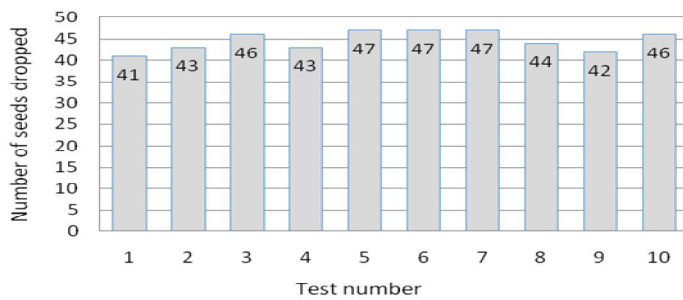

**Figure 7.** Simulation results: (a) path simulation; (b) position errors in X-axis; (c) position errors in Y-axis

### Seeding System's Accuracy and Field Test

We tested the accuracy of the rice seeding system in terms of the number of seeds dropped by dropping 49 seeds per round for ten rounds. The robot was tested without moving. Figure 8 shows the numbers of seeds dropped from the ten rounds, which varied between 41-47 seeds. The average seeding accuracy of the system was 91%.

In the field test the mobile robot was tested on a rough paddy field with an area of about one rai (1,600 m<sup>2</sup>). The target path for the robot is shown in Figure 9. Position A was the starting position. The robot first moved from position A to position B. Then it made a U-turn and moved to position C and so on, completing a total of four rows along the target path. It stopped every 1.6 metres to drop the rice seeds, making 12 stops along each row. At each stop, the robot dropped 49 seeds (one seed per dropping point). Figure 10 shows the robot moving on the paddy field. In Table 2 the average seed-dropping distances from one side of the field (such as position A-B in Figure 9) are compared with the target distances. The average error is about 5 cm. Table 3 shows the average number of seeds dropped per dropping location (expected number = 49), with an average error of about 4 seeds or 92% accuracy. Note that the results for each location in Tables 2 and 3 are reported using the averages across the four rows along the path.



**Figure 8.** Result of seeding accuracy test

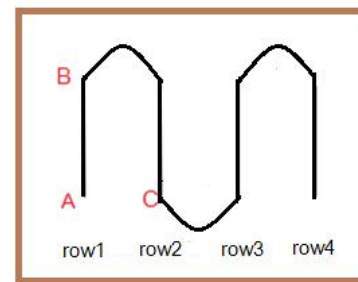

**Figure 9.** Target path for robot

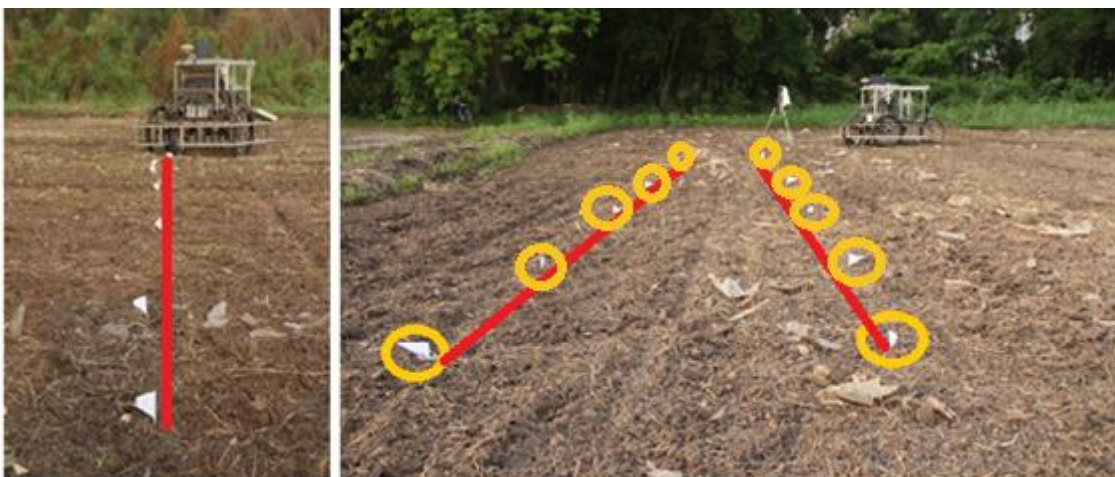

**Figure 10.** Experiment in paddy field: white flags represent actual seed dropping locations, highlighted with yellow circles to increase visibility.

**Table 2.** Average seed-dropping distances from field trial

Location	1	2	3	4	5	6	7	8	9	10	11	12
Average (m)	0	1.55	3.14	4.76	6.37	8.01	9.62	11.22	12.84	14.47	16.19	17.68
Target (m)	0	1.60	3.20	4.80	6.40	8.00	9.60	11.20	12.80	14.40	16.00	17.60
Error (m)	0	0.05	0.06	0.04	0.03	0.01	0.02	0.02	0.04	0.07	0.19	0.08

**Table 3.** Average number of dropped seeds from field trial

Location	1	2	3	4	5	6	7	8	9	10	11	12
Average (seeds)	46	43	47	44	46	46	47	45	44	41	46	46
Error (seeds)	3	6	2	5	3	3	2	4	5	8	3	3

### Comparison with Tractor Seeder

A comparison of performance between our three-wheel robot seeder and the traditional tractor seeder [11] is shown in Table 4. The former has a lower (hence better) seeding rate and higher seeding efficiency, but the drawbacks of the three-wheel robot are the high cost and the long working time. Note that the working time is the total time spent to complete one rai. The three-wheel robot runs automatically whereas the traditional tractor seeder is controlled manually.

**Table 4.** Comparative performance between three-wheel robot and the traditional tractor seeder

Seeder performance	Three-wheel seeding robot	Traditional tractor seeder
Seeding rate	3kg/rai	14 kg/rai
Seeder cost	100,000 Baht (~3,000 USD)	50,000 Baht (~1,500 USD)
Seeding efficiency	92%	76-82 %
Intra-row spacing	25 cm	25-30 cm
Working time	102.6 min./rai	15 min./rai

### CONCLUSIONS

The innovation described in this paper has four main contributions: 1) a mechanic design for automated direct rice seeding system; 2) a mathematical model for the dynamic control of a three-wheel robot while most existing agricultural machines are based on a four-wheel system; 3) the applied EKF algorithm for sensor fusion to accurately track the robot system; and 4) the PID- and PD-based control systems provided for driving the control and steering control respectively. In a simulation the position from the EKF estimation was closer to the true path than are the measured and model paths. In a field test a 92% accuracy for the number of dropped seeds and an error of 5 cm in the dropping position was obtained.

### ACKNOWLEDGEMENTS

The support by the Agricultural Research Development Agency (Thailand) under contract number PRP5505020380 and by the National Research University Project, Office of Higher

Education Commission (WCU-067-HS-57) was gratefully acknowledged.

## REFERENCES

1. Y. Nishimura, K. Hayashi, T. Goto and M. Horio, "Precision-drilling methods for the direct sowing of rice in flooded paddy fields", Proceedings of World Rice Research Conference, **2005**, Tsukuba, Japan, pp.238-240.
2. Y. Nagasaka, K. Taniwaki, R. Otani and K. Shigeta, "An automated rice transplanter with RTKGPS and FOG", *Agric. Eng. Int. CIGR J. Sci. Res. Devel.*, **2002**, 4, 41-46.
3. Y. Nagasaka, Y. Kanetani, N. Umeda and T. Kokuryu, "High-precision autonomous operation using an unmanned rice transplanter", Proceedings of World Rice Research Conference, **2005**, Tsukuba, Japan, pp.235-238.
4. S. Yoshinaga, "Improved lodging resistance in rice (*Oryza Sativa* L.) cultivated by submerged direct seeding using a newly developed hill seeder", *Jpn. Agric. Res. Quart.*, **2005**, 39, 147-152.
5. I. Chaorakam, M. Koike, T. Takigawa, A. Yoda, H. Hasegawa and B. Bahalayodhin, "Field evaluation of slot openers for minimum tillage (part 3) – dried soil cover on the slot", *Maejo Int. J. Sci. Technol.*, **2009**, 1(*Sp. Iss.*), 95-105.
6. N. Noguchi and O. C. Barawid Jr., "Robot farming system using multiple robot tractors in Japan agriculture", Proceedings of 18<sup>th</sup> IFAC World Congress, **2011**, Milano, Italy, pp.633-637.
7. T. Watwai, C. Pruetong and M. Ekpanyapong, "A tray-based direct rice seeding machine", *DIP Thailand 1301007037* (**2014**).
8. A. J. Weinstein and K. L. Moore, "Pose estimation of Ackerman steering vehicles for outdoors autonomous navigation", Proceedings of IEEE International Conference on Industrial Technology, **2010**, Vina del Mar, Chile, pp.579-584.
9. J. Aranda, J. M. Diaz, S. D. Canto, R. Munoz and C. H. Cuesta, "An overview about dynamic positioning of ships", in "Automation for the Maritime Industries" (Ed. J. Aranda, M. A. Armada and J. M. De la Cruz), 1<sup>st</sup> Edn., Produccion Grafica Multimedia, Madrid, **2005**, Ch.4.
10. R. C. Dorf, "The Engineering Handbook", 2<sup>nd</sup> Edn., CRC Press, Boca Raton, **2004**, pp.105-9–105-10.
11. S. Nakwattanukul, J. Mongkoltanatas, D. Sarathunphithak and C. Chaisattapagon, "Testing and development of rice planters attached to farm tractor", Final Research Report, **2007**, Department of Agricultural, Thailand.